

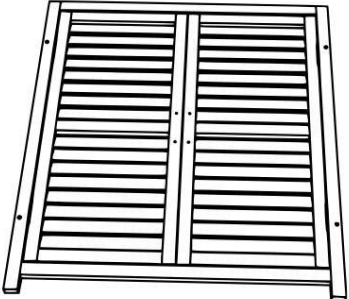

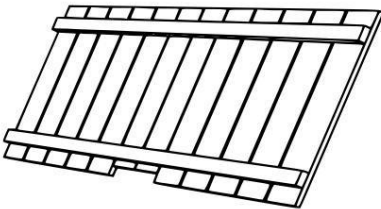

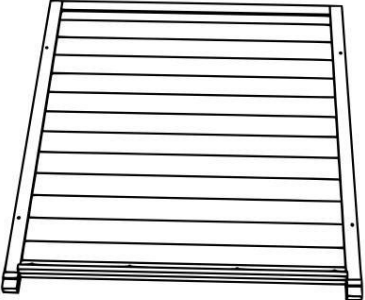

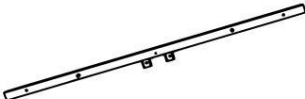

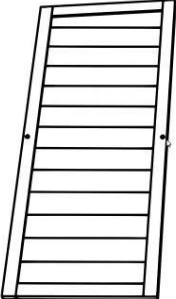

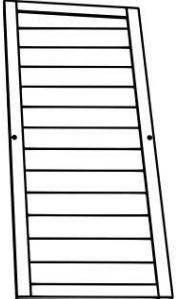

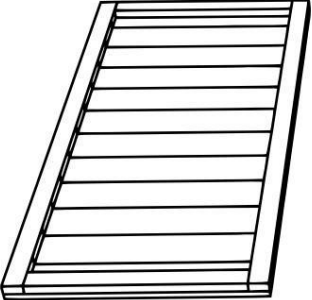
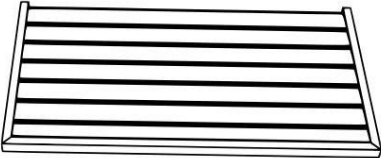
No	Postava	množství	No	Postava	množství
1		1	6		1
2		1	7		1
3		1	8		1
4		1	9		2
5		1	10		1

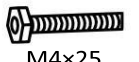

A	B	C	D	E	F
 3,5x40	 3,5x35	 3,5x30	 M4x25		
8	5	8	4	2	4

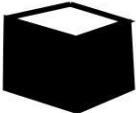
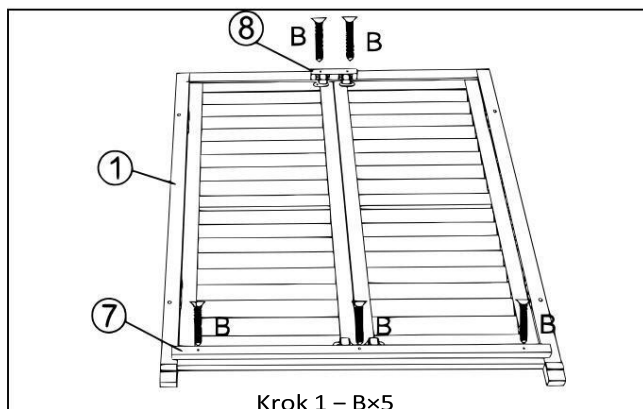

Krok 1 – Bx5

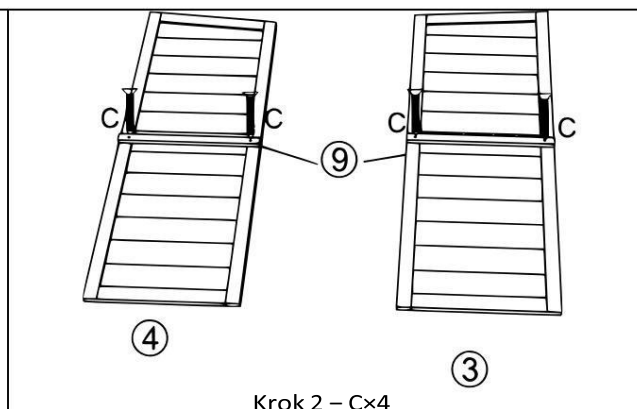

Krok 2 – Cx4

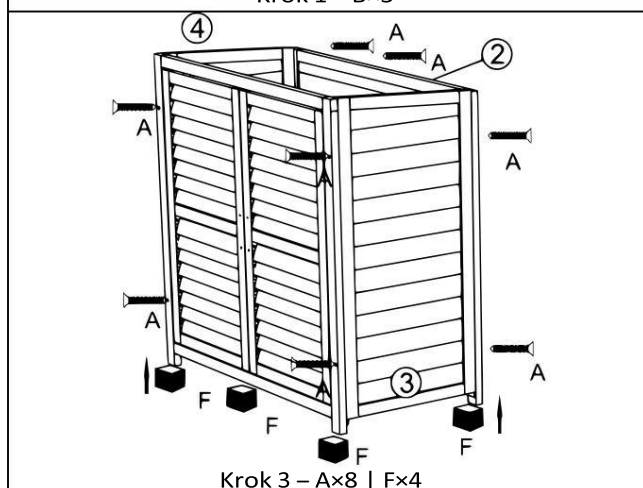

Krok 3 – Ax8 | Fx4

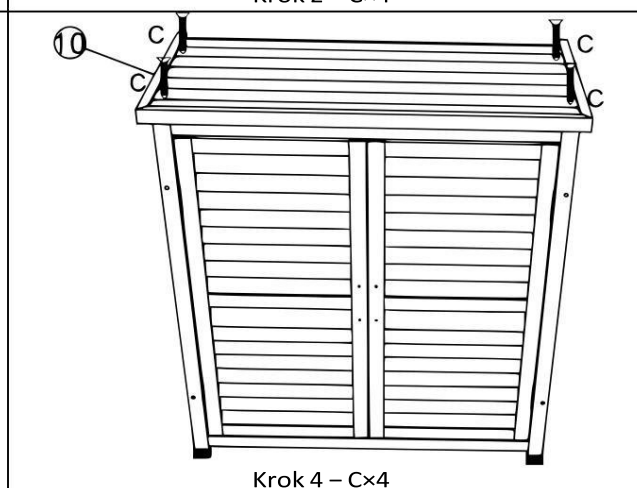

Krok 4 – Cx4

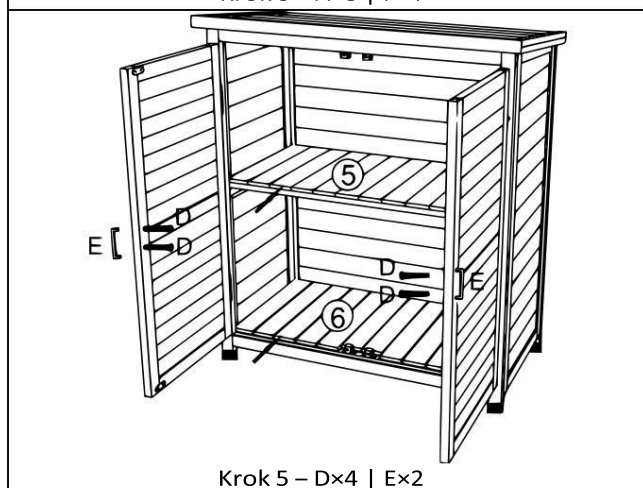

Krok 5 – Dx4 | Ex2

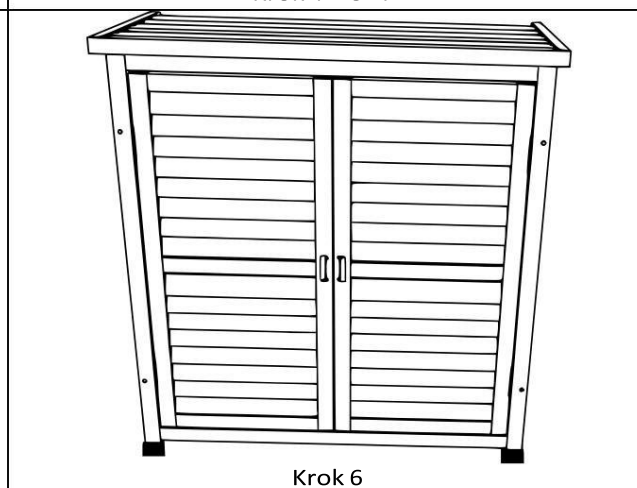

Krok 6

Důležitá poznámka:

Reprodukce a jakékoli komerční použití (části) tohoto návodu k obsluze vyžaduje písemné povolení společnosti WilTec Wildanger Technik GmbH.